

# ENERGIZER E95

**D**

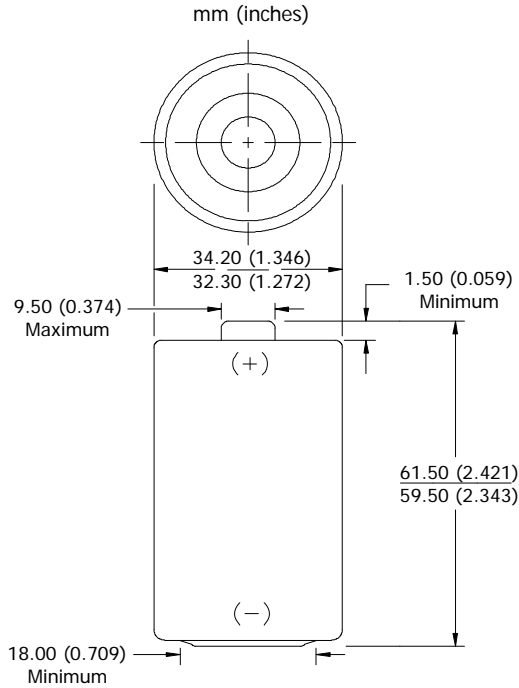

## Industry Standard Dimensions



## Specifications

<b>Classification:</b>	Alkaline
<b>Chemical System:</b>	Zinc-Manganese Dioxide (Zn/MnO <sub>2</sub> ) No added mercury or cadmium
<b>Designation:</b>	ANSI-13A, IEC-LR20
<b>Nominal Voltage:</b>	1.5 volts
<b>Nominal IR:</b>	150 to 300 milliohms (fresh)*
<b>Operating Temp:</b>	-18°C to 55°C (0°F to 130°F)
<b>Typical Weight:</b>	148.0 grams (5.2 oz.)
<b>Typical Volume:</b>	56.0 cubic centimeters (3.4 cubic inch)
<b>Jacket:</b>	Plastic Label
<b>Shelf Life:</b>	7 years at 21°C (80% of initial capacity)
<b>Terminal:</b>	Flat Contact

\* For additional information, please reference the [IR technical white paper](#).

## Milliamp-Hours Capacity

Continuous discharge to 0.8 volts at 21°C

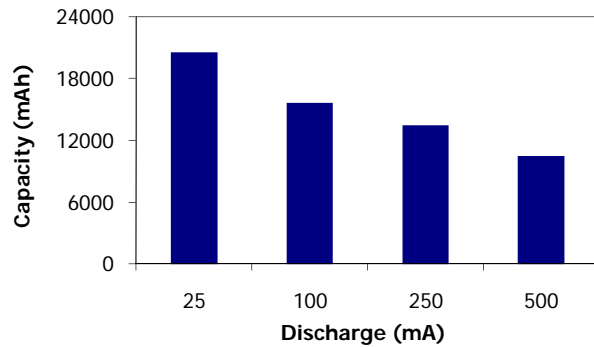

## Device Selection Guide:

- Portable Stereo
- Toy
- Lighting
- Radio

## Battery Selection Indicator

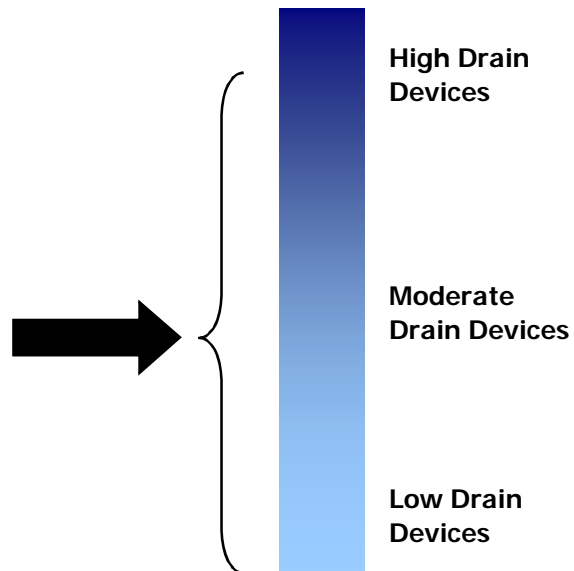

### Important Notice

This data sheet contains typical information specific to products manufactured at the time of its publication.  
©Energizer Holdings, Inc. - Contents herein do not constitute a warranty.

**ENERGIZER E95**



**Constant Resistance Performance**

Typical Characteristics (21°C)

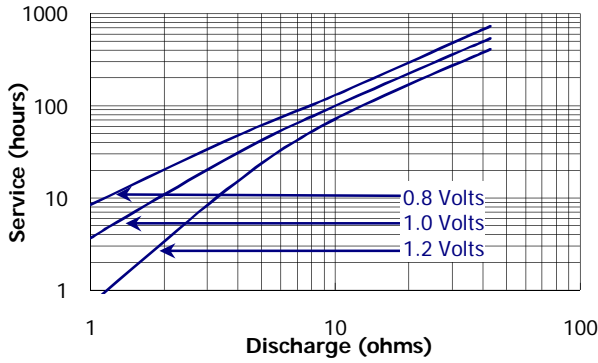

**Constant Current Performance**

Typical Characteristics (21°C)

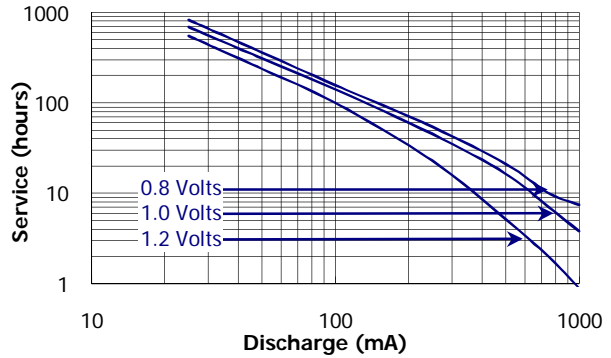

**Industry Standard Tests (21°C)**

**RADIO**  
10 ohm 4 hrs/day

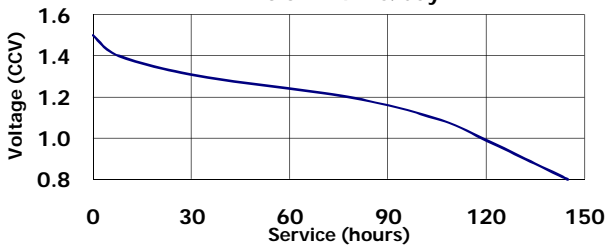

**LIGHTING**  
1.5 ohm HIF

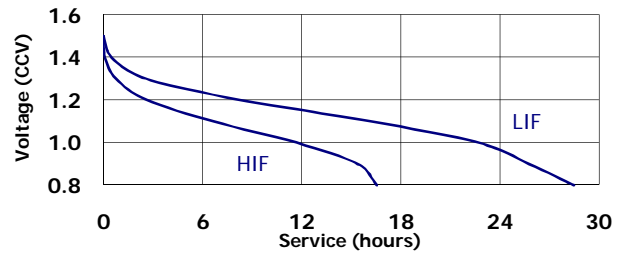

**TOY**  
2.2 ohm 1 hr/day

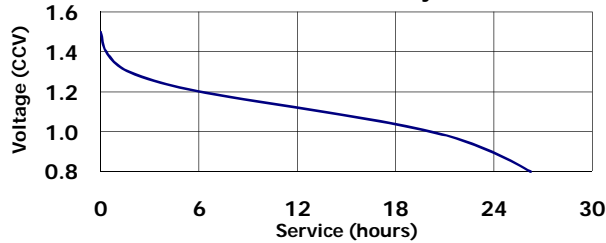

**PORTABLE STEREO**  
600 mA 2 hrs/day

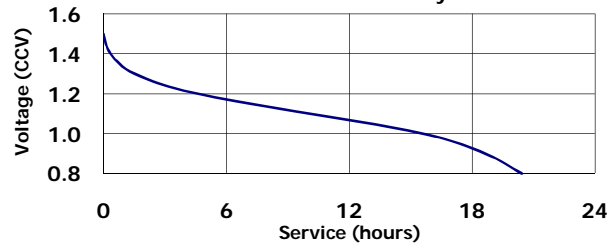

**Important Notice**

This data sheet contains typical information specific to products manufactured at the time of its publication.  
©Energizer Holdings, Inc. - Contents herein do not constitute a warranty.