

ENERGIZER L92
Ultimate Lithium

AAA

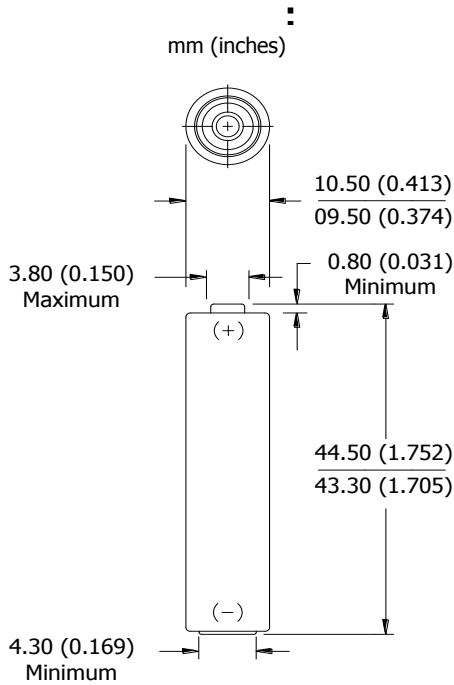

9 0 "Cylindrical Lithium"
9 0 0 Lithium/Iron Disulfide (Li/FeS₂)
: 0 0 ANSI 24-LF, IEC-FR03
9 0 0 1.5 Volts
0 0 [EA92, E92, NH12, 1212](#)
0 0 -40°C to 60°C (-40°F to 140°F)
0 0 -40°C to 60°C (-40°F to 140°F)*
0 0 7.6 grams (0.3 oz.)
: 0 0 3.8 cubic centimeters (0.2 cubic inch)
0 0 1.5 Amps Continuous
(single battery only) 2.0Amps Pulse (2 sec on / 8 sec off)
9 0 2 uA
9 0 Less than 1 gram
0 0 140 to 300 milliohms (depending on method)
0 0 20 years at 21°C
9 0 [Please refer to PSDS Document](#)

This battery has Underwriters Laboratories component recognition (MH29980)

Certified for intrinsic safety 710024

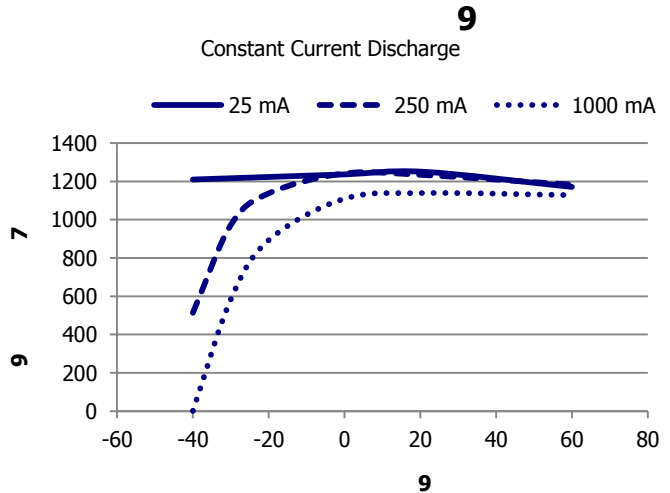
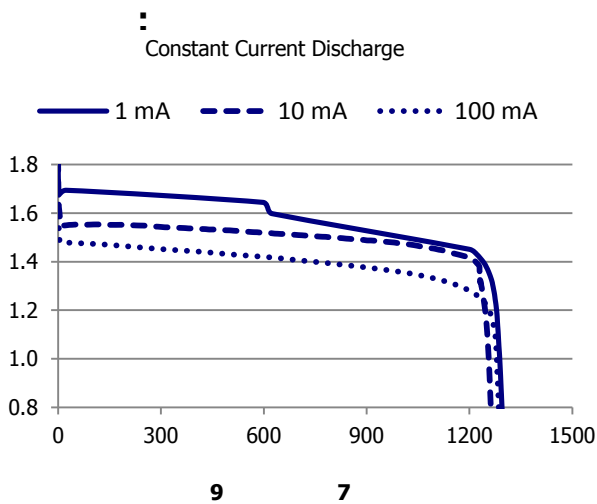
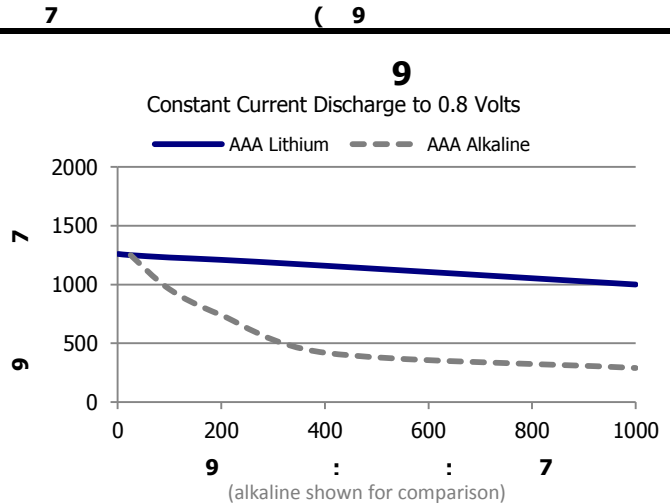

This datasheet contains typical information specific to products manufactured at the time of its publication.

ENERGIZER L92

AAA

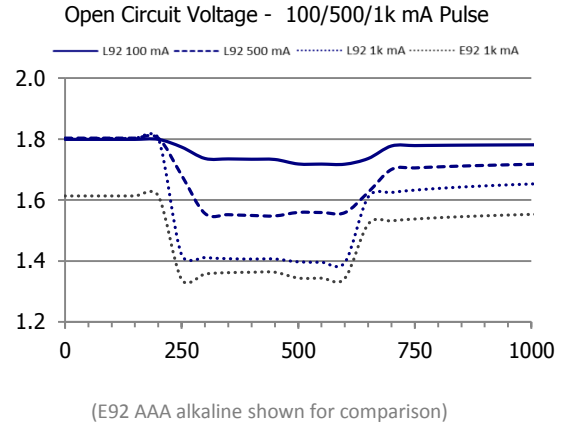
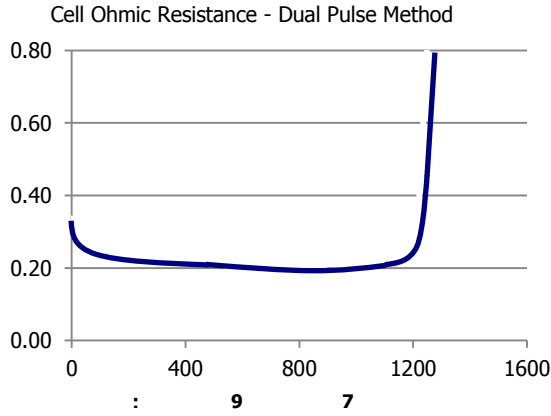

9 Typical Characteristics to 0.8 Volts

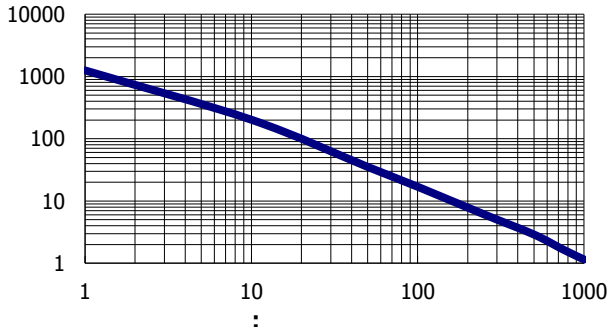

9 Typical Characteristics to 0.8 Volts

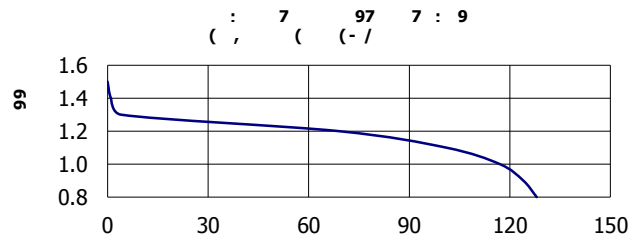
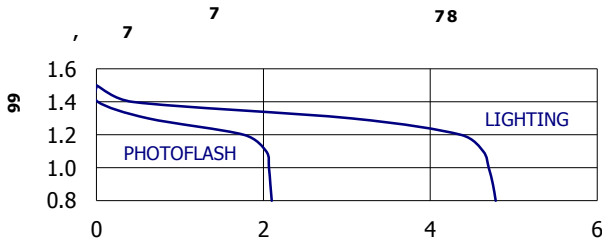
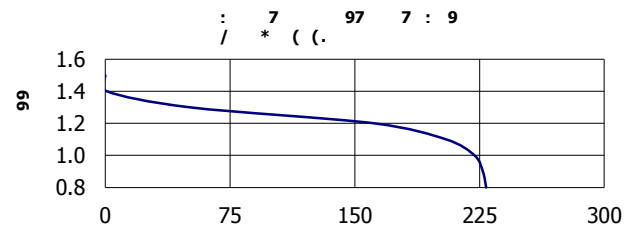
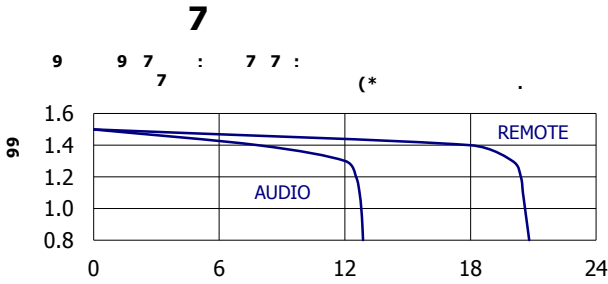
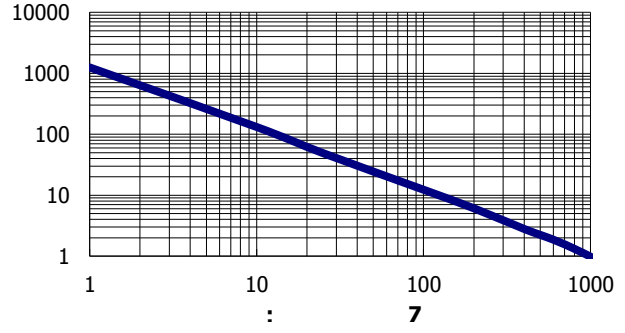

This datasheet contains typical information specific to products manufactured at the time of its publication.

9